



Summer®

Please read the following instructions carefully.
Keep this instruction manual for future reference.

Tools required: Phillips head screwdriver (not included).

**For Technical Support Call 1-800-268-6237 or
E-Mail at customerservice@summerinfant.com**

WARNING:

This product contains small parts. Adult assembly required.
Exercise care when unpacking and assembling product.

For use with children birth and up.

INSTRUCTION MANUAL

SURE AND SECURE™ DELUXE WOOD WALK-THRU GATE

Thank you for buying the Sure and Secure™ Deluxe Wood Walk-Thru Gate from Summer Infant. This pressure-mounted gate helps you create and maintain a secure environment for your child. It has a hinged swinging door that opens easily in either direction with one hand. It also swings closed automatically. It's fully adjustable to fit openings from 29.5"– 33.5". In normal use there is no need for mounting holes that damage woodwork and walls. For added security use the mounting cups and screws that are provided.

Please read all the instructions before installing the gate.



WARNING: IMPORTANT! KEEP FOR FUTURE REFERENCE!

- To prevent serious injury or death, securely install gate and use according to manufacturer's instructions.
- Never use with a child able to climb over or dislodge the gate.
- Never leave child unattended.
- Use only with lock securely engaged.
- Do not use if any components are missing or damaged.
- This product should not be used at the top of stairs without mounting the wall mounting cups to the wall first.
- This product will not necessarily prevent all accidents. Proper adult supervision is required at all times.

CAUTION: KEEP SMALL PARTS OUT OF CHILD'S REACH.

FEATURES & COMPONENTS:

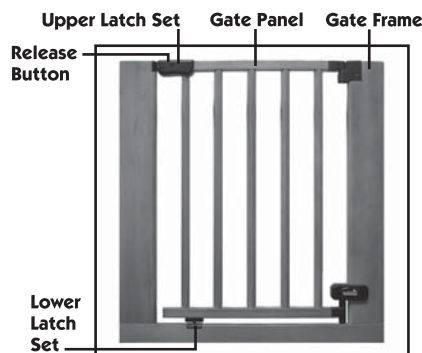

Tension Bolts (four)



Mounting Cups (four)



Adhesive Mounting Pads (four)



Screws (four)



Wall Anchors (four)



Wrench



SET UP:

- 1 Measure the width of the opening where you intend to install the gate.

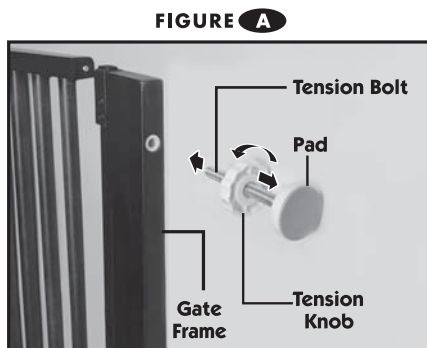

FIGURE A

- 2 Screw the tension knobs down the tension bolts until they contact the pads. Insert 4 tension bolts into holes on outside and slide inward towards frame as far as possible.

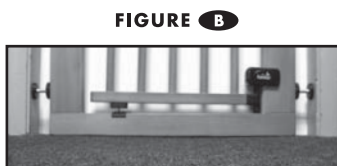

FIGURE B

- 3 Place the gate in the opening so that the bottom of the gate frame is completely flat on the floor, as shown in Figure B.

Optional mounting cup installation: Fasten mounting cups to the doorframe or studs with screws as shown in Figure C. If mounting into wall use wall anchors.

Note: The adhesive mounting pads are included only for positioning the mounting cups and must be used in conjunction with screws.



FIGURE C



FIGURE D

OPERATION:

To open the gate: (see Figure K)

1. Slide the release button away from the door frame or wall.
2. Lift up the gate panel.
3. Swing open in either direction.

To close the gate:

Simply release the gate and it will close automatically.

Caution: After closing the gate, ALWAYS check to be certain that it is latched securely

Troubleshooting

If the gate does not stay closed:

1. The Upper latch set is not properly adjusted.

Solution: Adjust the upper tension knobs by turning them counter-clockwise to release tension or clockwise to increase tension. Ensure that the upper latch set

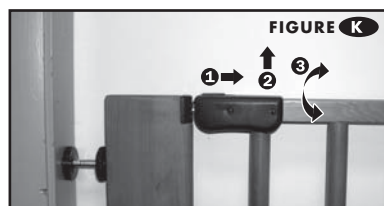

FIGURE K

MAINTENANCE:

1. Regularly check tension knobs and rubber pads to make sure the gate is securely in place.
2. Do not use the gate if any components are damaged or missing.
3. Wipe surface with a damp cloth or sponge using mild detergent and warm water.

- 4 Center the gate in the opening, so that the distance from the bottom of gate frame to each side wall is equal, as shown in Figure E. Use the marks etched into the wrench as a ruler. Slide the tension bolts out until the pads contact the door frame or wall. Then screw the tension knob away from the pad until it contacts the gate frame as shown in Figure F.



FIGURE E

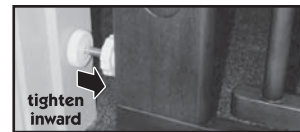

FIGURE F

- 5 Tighten both of the tension knobs on the bottom inward towards the frame at the same time, as shown in Figure G. Then tighten both of the tension knobs on the top inward towards the frame at the same time, as shown in Figure H, so that the upper latch set goes below the release button completely, as shown in Figure J.

To verify installation: Push the frame to ensure that it is secure in the opening and then push the gate panel to ensure that the upper and lower latch sets lock securely in the housings on the frame, as shown in Figures I and J.



FIGURE G

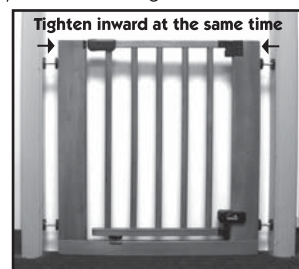

FIGURE H

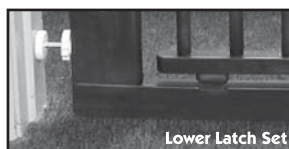

FIGURE I



FIGURE J

Note: Wrench is provided for final tightening of all four tension knobs (if necessary), as shown in Figure D.

Note: If gate is difficult to unlatch, top tension knobs may be too tight.

button always remains below the release button as shown in Figure J. Also ensure that the upper latch set button engages securely when the gate swings closed and that it can be released properly when the release button is pushed.

2. Lower latch set position is too low.

Solution: Although unusual, some door frames may be out of alignment. In this case you may have to adjust the individual tension knobs to ensure that the gate is aligned properly. Make sure the upper latch set is still below the release button as shown in Figure J.

If the gate does not stay in position it may not be installed properly as shown in Figure J. Remove and reinstall the gate, making sure the gate is installed correctly as shown in Figure L.

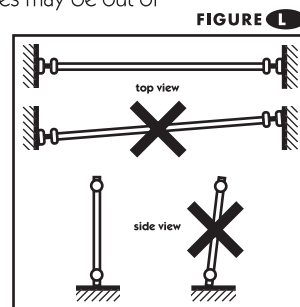

FIGURE L

We at Summer Infant stand behind all of our products. If you are not completely satisfied or have any questions, please contact our Customer Service Department at 1-800-268-6237 or e-mail us at customerservice@summerinfant.com

© 2005 Summer Infant, Inc.
6 Blackstone Valley Place
Suite 206
Lincoln, RI 02865 USA
1-800-268-6237

www.summerinfant.com

MADE IN CHINA.

Colors and styles may vary.